



A Division of Systems, LLC

# UniChock®

## Vehicle Restraint

### Owner's/User's Manual



McGuire • Division of Systems, LLC • W194 N11481 McCormick Drive • Germantown, WI 53022  
800.624.8473 • fax: 262.255.5917 • [www.wbmcguire.com](http://www.wbmcguire.com) • [techservices@loadingdocksystems.com](mailto:techservices@loadingdocksystems.com)

Printed in U.S.A.  
© 2023 Systems, LLC - All Rights Reserved

Manual No. 4111-0047  
Feb 2023

# Table of Contents

Page

## Precautions

Recognize Cautionary Information .....	1
General Operational Precautions .....	1
Operational Precautions .....	2
Safety Decals.....	4
Placard .....	5
Owner's/User's Responsibilities .....	6

## Introduction

General Information.....	8
Component Identification.....	9

## Installation

Installation Precautions .....	10
Installation Notes .....	10
Installation Overview .....	11
Installation Instructions .....	12
Install Control Panel and Wiring .....	17
Placard Installation Instructions .....	18

## Operation

Operational Precautions .....	19
-------------------------------	----

## Maintenance

Periodic Maintenance .....	25
----------------------------	----

## Parts

OSLA (Outside Light Assembly).....	26
------------------------------------	----

## Miscellaneous

Customer Information .....	30
Warranty.....	Back Cover

# PRECAUTIONS

## Recognize Precautionary Information

### Safety-Alert Symbol



The Safety-Alert Symbol is a graphic representation intended to convey a safety message without the use of words. When you see this symbol, be alert to the possibility of death or serious injury. Follow the instructions in the safety message panel.

### **DANGER**

The use of the word DANGER signifies the presence of an extreme hazard or unsafe practice which will most likely result in death or severe injury.

### **WARNING**

The use of the word WARNING signifies the presence of a serious hazard or unsafe practice which could result in death or serious injury.

### **CAUTION**

The use of the word CAUTION signifies possible hazard or unsafe practice which could result in minor or moderate injury.

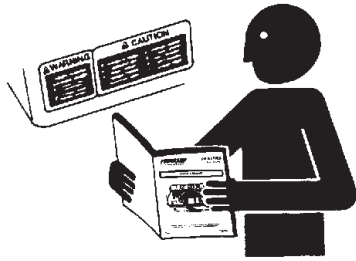
### **NOTICE**

The use of the word NOTICE indicates information considered important, but not hazard-related, to prevent machine or property damage.

### **SAFETY INSTRUCTIONS**

Indicates a type of safety sign, or separate panel on a safety sign, where safety-related instructions or procedures are described.

## General Operational Precautions



Read and understand the Owner's/User's Manual and become thoroughly familiar with the equipment and its controls before operating the equipment.

Never operate equipment while a safety device or guard is removed or disconnected.

Never remove DANGER, WARNING, or CAUTION signs, Placards or Decals on the equipment unless replacing them.

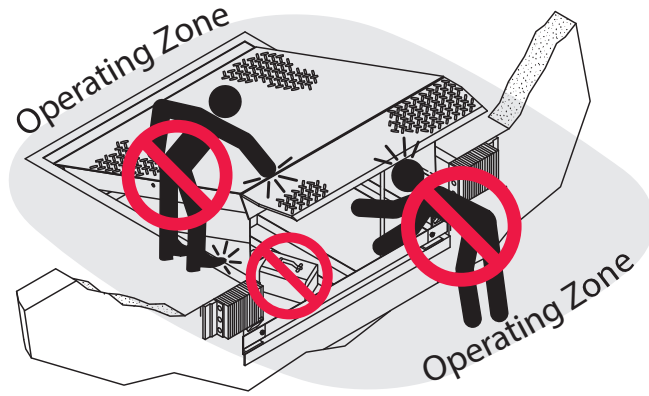



Figure 1

Do not start the equipment until all unauthorized personnel in the area have been warned and have moved outside the operating zone (Figure 1).

Remove any tools or foreign objects from the operating zone before starting.

Keep the operating zone free of obstacles that could cause a person to trip or fall.

 **WARNING:** This product can expose you to chemicals including lead, which are known to the State of California to cause cancer or birth defects or other reproductive harm. For more information go to [www.P65Warnings.ca.gov](http://www.P65Warnings.ca.gov)

# PRECAUTIONS

## Operational Precautions



Learn the safe way to operate this equipment. Read and understand the manufacturer's instructions. If you have any questions, ask your supervisor.

### **DANGER**



Stay clear of dock leveling device when transport vehicle is entering or leaving area.



Do not move or use the dock leveling device if anyone is under or in front of it.



Keep hands and feet clear of pinch points. Avoid putting any part of your body near moving parts.

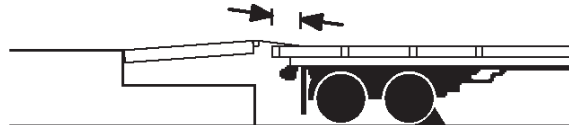
### **WARNING**



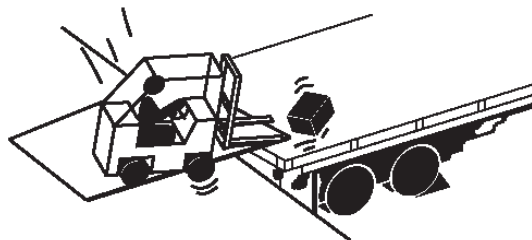
Chock/restrain all transport vehicles. Never remove the wheel chocks or release the restraining device until loading or unloading is finished, and transport driver has been given permission to drive away.



Do not use a broken or damaged dock leveling device or restraining device. Make sure proper service and maintenance procedures have been performed before using.



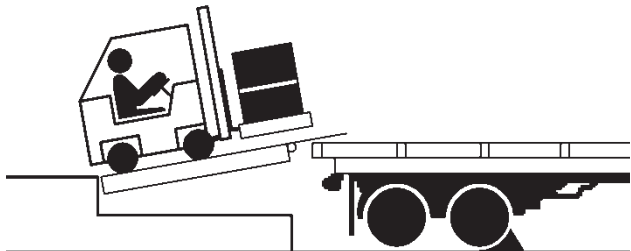
Make sure lip overlaps onto transport vehicle bed at least 4 in. (102 mm).



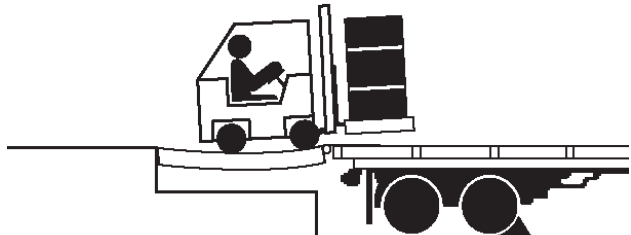
Keep a safe distance from both side edges.

Operational Precautions

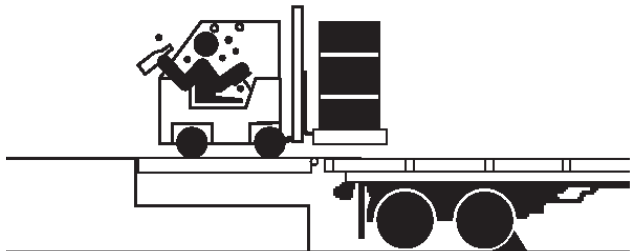
 **WARNING**



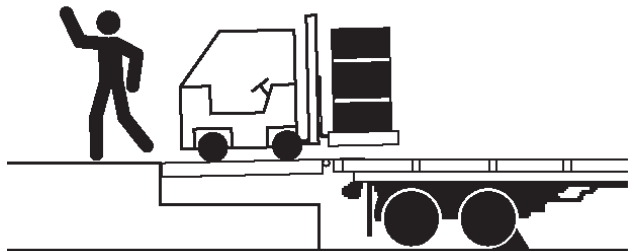
Do not use dock leveling device if transport vehicle is too high or too low.



Do not overload the dock leveling device.



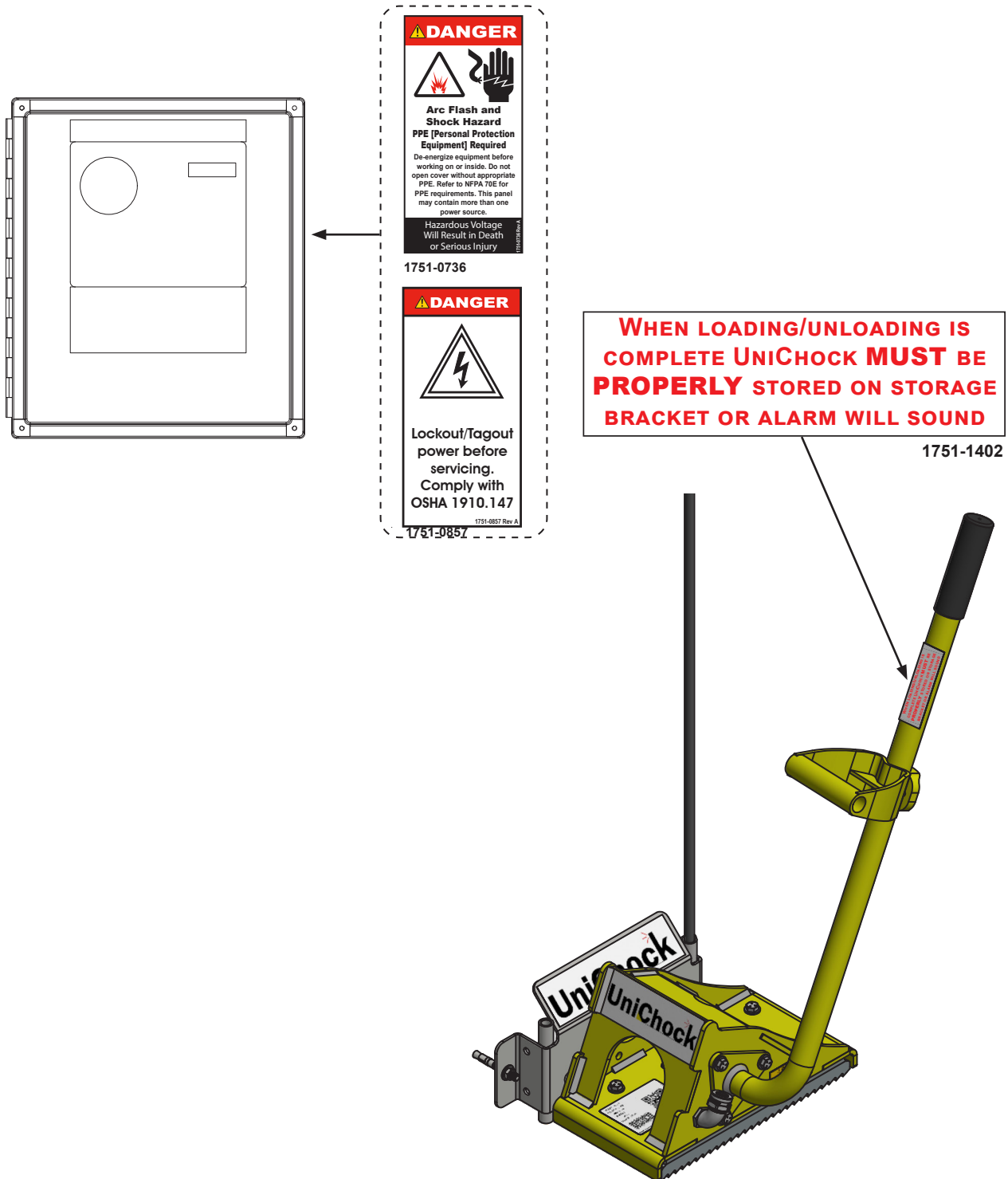
Do not operate any equipment while under the influence of alcohol or drugs.



Do not leave equipment or material unattended on dock leveling device.

# PRECAUTIONS


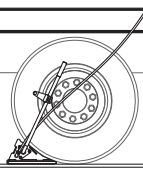

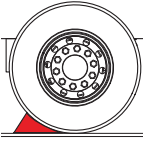
## Safety Decals



\*Control box appearance may vary depending on options.

Figure 2


## Placard

<div data-bbox="248 304 755 394"> <b>DANGER</b></div> <ul style="list-style-type: none"><li>• Read and follow all instructions, warnings, and maintenance schedules in the manual and on placards.</li><li>• Wheel chock restraint operation and servicing is restricted to authorized personnel.</li></ul> <ol style="list-style-type: none"><li>1. Before using the vehicle restraint:<ul style="list-style-type: none"><li>• Remove any debris, snow, or ice that may obstruct the operation of the wheel chock to restrain the transport vehicle.</li><li>• Alert personnel in the area of potential operation of the wheel chocking system.</li><li>• Operate the wheel chocking system through one complete cycle, inspecting it for proper operation and light sequence. Advise maintenance personnel of any damage or improper operation immediately. Remove all malfunctioning or damaged wheel chocking systems from service using approved lockout/tagout procedures.</li></ul></li><li>2. Before attempting to restrain a transport vehicle:<ul style="list-style-type: none"><li>• Verify that transport vehicle is positioned squarely against dock bumpers.</li><li>• Inspect the transport vehicle's wheel area. Fenders or shrouds near the wheel may obstruct and not allow the wheel chocking system to securely capture the transport vehicle wheel.</li></ul></li><li>3. After activating vehicle restraint:<ul style="list-style-type: none"><li>• Verify that the wheel chock is fully engaged and centered with vehicle tire.</li><li>• If equipped with a light communication system, load and unload on GREEN light only.</li></ul></li><li>4. Maintenance or service must be performed by authorized personnel only. Follow approved lockout/tagout procedures.</li></ol> <p><b>FAILURE TO FOLLOW THESE INSTRUCTIONS WILL RESULT IN DEATH OR OTHER SERIOUS INJURY.</b></p>	<div data-bbox="966 294 1421 388"><h3>OPERATING INSTRUCTIONS</h3></div> <div data-bbox="998 409 1372 451"><h4>VEHICLE RESTRAINTS</h4><p><small>Only for UniChock™</small></p></div> <div data-bbox="1006 472 1234 493"><h5>ENGAGE WHEEL CHOCK</h5></div> <div data-bbox="860 493 998 640"></div> <ol style="list-style-type: none"><li>1. Place chock in front of wheel. (Inside AMBER light indicates chocking in process)</li><li>2. Alarm &amp; GREEN inside light will indicate proper engagement with the wheel.</li><li>3. Control box display will prompt to open overhead door and/or operate leveler.</li></ol> <p><b>Note:</b> RED/AMBER inside light will indicate if not properly engaged with wheel.</p> <div data-bbox="1006 672 1209 693"><h5>RELEASE RESTRAINT</h5></div> <div data-bbox="868 745 982 913"></div> <ol style="list-style-type: none"><li>1. When loading/unloading is complete store leveler and close overhead door.</li><li>2. To change light communication:<ol style="list-style-type: none"><li>a. Manual light change requires operator to press the DOCK ALERT STATUS button.</li><li>b. Automatic light change requires the leveler to be stored or overhead door closed.</li></ol></li><li>3. Outside light will start to alternate RED &amp; GREEN to indicate it is safe to remove the wheel chock. Inside light will be AMBER to indicate chock maybe in process of returning to the stored position.</li><li>4. Wheel chock must be returned onto the storage bracket to properly complete the sequence of operation.</li></ol> <div data-bbox="1006 976 1096 997"><h5>BY-PASS</h5></div> <ol style="list-style-type: none"><li>1. If the UniChock is not able to chock the wheel or provide proper light communication, it is still required use a wheel chock to restrain transport vehicle.</li><li>2. Chock must be stored on bracket.</li><li>3. Press the DOCK ALERT STATUS button.</li><li>4. Inside light is GREEN/AMBER and outside light is RED.</li><li>5. Place chock in front of wheel.</li><li>6. Loading/unloading may proceed with caution.</li></ol> <div data-bbox="860 1102 998 1249"></div> <div data-bbox="1006 1197 1396 1218"><h5>BY-PASS RESET (RETURN TO NORMAL OPERATION)</h5></div> <ol style="list-style-type: none"><li>1. When loading/unloading is complete remove wheel chock and store it on wall bracket.</li><li>2. Press the DOCK ALERT STATUS button.</li><li>3. Lights change to RED inside and GREEN outside.</li></ol>
--	---



Scan to view our owner's/user's manuals online.  
[www.LoadingDockSystems.com](http://www.LoadingDockSystems.com)  
**1.800.643.5424**  
Call for additional placards, or manuals, or with questions regarding proper use, maintenance, and repair of dock leveler.



 WARNING: CANCER AND REPRODUCTIVE HARM  
[www.P65Warnings.ca.gov](http://www.P65Warnings.ca.gov)

1751-1388

# OWNER'S/USER'S RESPONSIBILITIES

---

- 1) The manufacturer shall provide to the initial purchaser and make the following information readily available to the owners/users and their agents, all necessary information regarding Safety Information, Operation, Installation and Safety Precautions, Recommended Initial and Periodic Inspections Procedures, Planned Maintenance Schedule, Product Specifications, Troubleshooting Guide, Parts Break Down, Warranty Information, and Manufacturer's Contact Information.
- 2) The owner/user should recognize the inherent dangers of the interface between the loading dock and the transport vehicle. The owner/user should, therefore, train and instruct all operators in the safe operation and use of the restraining device in accordance with manufacturer's recommendations and industry standards. Effective operator training should also focus on the owner's/user's company policies, operating conditions and the manufacturer's specific instructions provided with the restraining device. Maintaining, updating and retraining all operators on safe working habits and operation of the equipment, regardless of previous experience, should be done on a regular basis and should include an understanding and familiarity with all functions of the equipment. Owners/users shall actively maintain, update and retrain all operators on safe working habits and operations of the equipment.
- 3) When selecting a restraining device, it is important to consider not only present requirements but also future plans and any possible adverse conditions, environmental factors or usage. The owners/users shall provide application information to the manufacturer to receive recommendations on appropriate equipment specifications.
- 4) The owner/user must see all nameplates, placards, decals, instructions and posted warnings are in place and legible and shall not be obscured from the view of the operator or maintenance personnel for whom such warnings are intended. Contact manufacturer for any replacements.
- 5) Modifications or alterations of restraining devices shall be made only with prior written approval from the original manufacturer. These changes shall be in conformance with all applicable provisions of the MH30.3 standard and shall also satisfy all safety recommendations of the original equipment manufacturer of the particular application.
- 6) An operator training program should consist of, but not necessarily be limited to, the following:
  - a) Select the operator carefully. Consider the physical qualifications, job attitude and aptitude.
  - b) Ensure that the operator reads and fully understands the complete manufacturer's owner's/user's manual.
  - c) Emphasize the impact of proper operation upon the operator, other personnel, material being handled, and equipment. Cite all rules and why they are formulated.
  - d) Describe the basic fundamentals of the restraining device and component's design as related to safety, e.g., mechanical limitation, stability, functionality, etc.
  - e) Introduce the equipment. Show the control locations and demonstrate functions. Explain how they work when used properly and maintained as well problems when they are used improperly.
  - f) Ensure that the operator understands nameplate data, placards and all precautionary information appearing on the restraining device.
  - g) Supervise operator practice of equipment.
  - h) Develop and administer written and practical performance tests. Evaluate progress during and at completion of the course.
  - i) Administer periodic refresher courses. These may be condensed versions of the primary course and include on-the-job operator evaluation.
- 7) It is recommended that the transport vehicle is positioned as close as practical to the dock leveling device and in contact with both bumpers. When an industrial vehicle is driven on or off a transport vehicle during loading and unloading operations, the transport vehicle parking brakes shall be applied and wheel chocks or a restraining device that provides equal or better protection of wheel chocks shall be engaged. Also, whenever possible, air-ride suspension systems should have the air exhausted prior to performing said loading and unloading operations.



# OWNER'S/USER'S RESPONSIBILITIES

---

- 8) When goods are transferred between the loading dock and a trailer resting on its support legs/ landing gear instead of a tractor fifth wheel or converter dolly, it is recommended that an adequate stabilizing device or devices shall be utilized at the front of the trailer.
- 9) In order to be entitled to the benefits of the standard product warranty, the dock safety equipment must have been properly installed, maintained and operated in accordance with all manufacturer's recommendations and/ or specified design parameters and not otherwise have been subject to abuse, misuse, misapplication, acts of nature, overloading, unauthorized repair or modification, application in a corrosive environment or lack of maintenance. Periodic lubrication, adjustment and inspection in accordance with all manufacturer's recommendations are the sole responsibility of the owner/user.
- 10) Manufacturer's recommended maintenance and inspection of all restraining devices shall be performed in conformance with the following practices: A planned maintenance schedule program must be followed, only trained and authorized personnel shall be permitted to maintain, repair, adjust and inspect restraining devices, and only original equipment manufacturer parts, manuals, maintenance instructions, labels, decals and placards or their equivalent shall be used. Written documentation of maintenance, replacement parts or damage should be kept. In the event of damage, notification to the manufacturer is required.
- 11) Restraining devices that are structurally damaged shall be removed from service, inspected by a manufacturer's authorized representative, and repaired or replaced as needed or recommended by the manufacturer before being placed back in service.

# INTRODUCTION

---

## General Information



**Figure 3**

This manual provides current information on the UniChock vehicle restraint. Due to ongoing product improvement, some parts may have changed, along with operation and troubleshooting methods. This manual describes these changes where applicable.

The UniChock is an intelligent wheel chock vehicle restraint, available as a standalone unit or integrated with other loading dock equipment.

The UniChock is stored on the exterior building wall or approach using a custom bracket. The UniChock is designed to outperform the traction of competitor wheel chocks, providing superior restraining abilities.

The durable, powder coated, aluminum housing is designed to withstand impact from trailers and provide weather resistance for all internal components.

The UniChock vehicle restraint is engaged manually, by removing the unit from its storage bracket and wedging the chock under a transport vehicle's rear wheel. The unit incorporates a sensor which detects a vehicle tire.

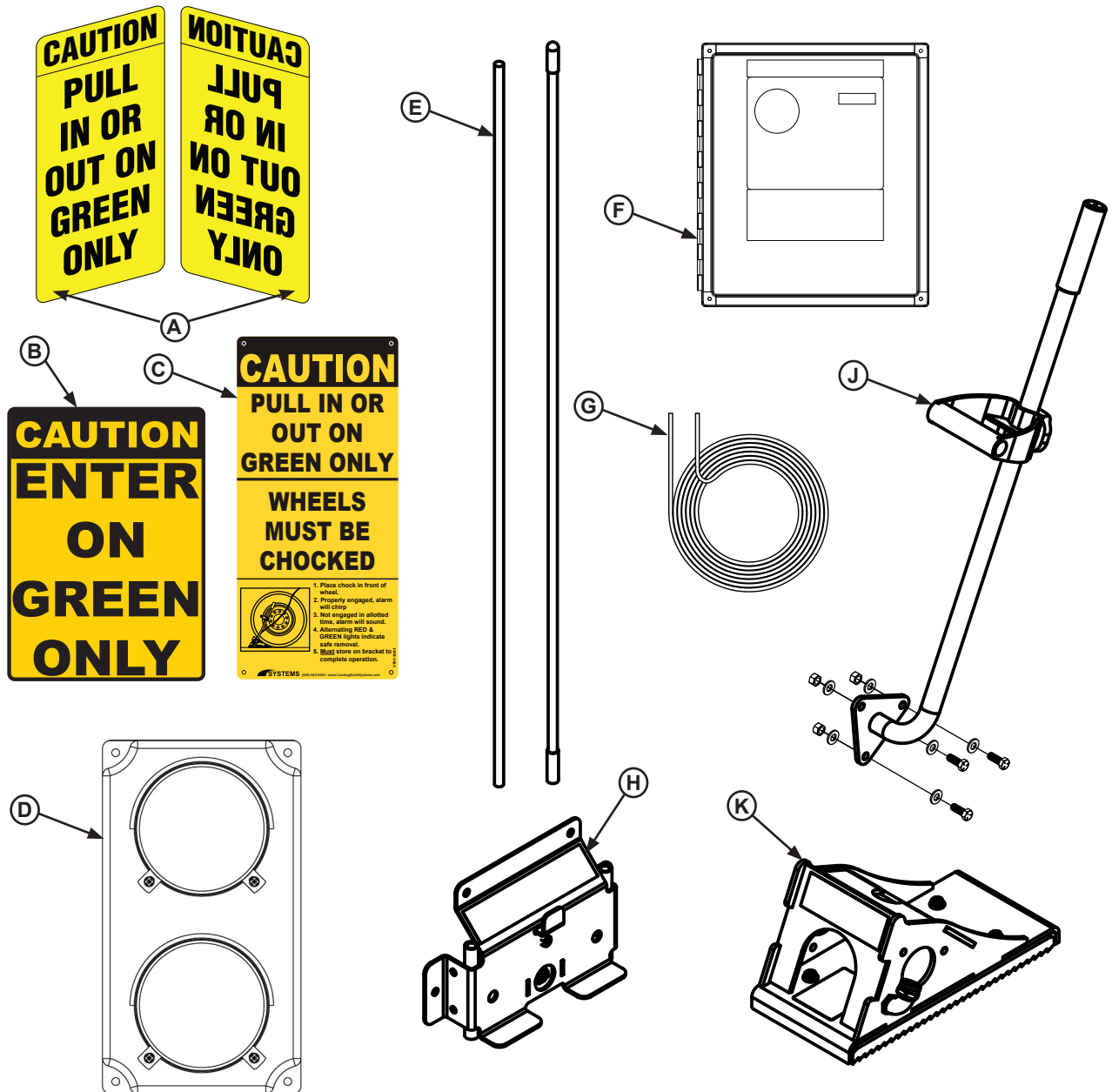
To illustrate which connections are to be made in the field at installation, electrical drawings are included with each order, or by contacting Systems, LLC Technical Services.

Call Systems, LLC to discuss available options to meet your specific needs.

**Technical Service at 800-643-5424 or [techservices@loadingdocksystems.com](mailto:techservices@loadingdocksystems.com)**

## Component Identification

Inspect package and all components. Report any missing or damaged items immediately and note on the shipping Bill Of Lading (BOL).



\*Control box appearance may vary depending on options.

Figure 4

- |   |                            |                       |
|---|----------------------------|-----------------------|
| A — Outside Sign, Pull In/Out           | D — Docking Control Lights | H — Storage Base      |
| B — Inside Sign, Enter On Green Only    | E — Fiberglass Rods        | J — Chock Base Handle |
| C — Outside Sign, Pull In/Out, UniChock | F — Control Box            | K — Chock Base        |
|   | G — Cable (x2)             |                       |

# INSTALLATION

## Installation Precautions

### **WARNING**

Post safety warnings and barricade the work area at dock level and ground level to prevent unauthorized use of the dock leveler before installation has been completed.

### **WARNING**

DO NOT grind or weld if hydraulic fluid or other flammable liquid is present on the surface to be ground or welded.

DO NOT grind or weld if uncontained hydraulic fluid or other flammable liquid is present. Stray sparks can ignite spills or leaks near the work area. Always clean up the oil leaks and spills before proceeding with grinding or welding.

Always keep a fire extinguisher of the proper type nearby when grinding or welding.

### **CAUTION**

Only trained installation professionals with the proper equipment should install this product.

### **NOTICE**

DO NOT connect the vehicle restraint electrical wiring and ground connections until all welding has been completed.

DO NOT ground welding equipment to any electrical components of the vehicle restraint. Always ground welding equipment to the vehicle restraint base, NEVER to the moving components.

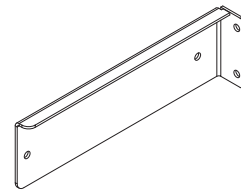
Failure to follow these instructions may damage the motor, wiring, and/or control panel.

## Installation Notes

- Place the control box on interior wall near the door opening, in plain sight of the leveler, within arms reach and near eye level.
- Allow adequate space for seals and shelters when mounting outside lights, signs.
- Junction box mounted on dock face should not extend beyond 3". Supplied by others.
- There are multiple options to mount the storage bracket to address various obstacles and building configurations. See installation instructions to understand each one.

### Storage Bracket Mounting

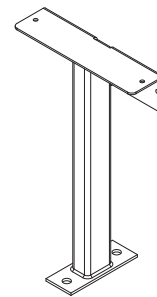
- Located 12"-18" off drive.
- Optional mounting bracket is available to rotate the mounting 90 degrees for narrow door centerlines.



9971-0034 — 90 deg Mounting Bracket

Figure 5

- Separate standoff mounting bracket is required when:
  - Dock shelters are present
  - Downspout/downspout guard is present



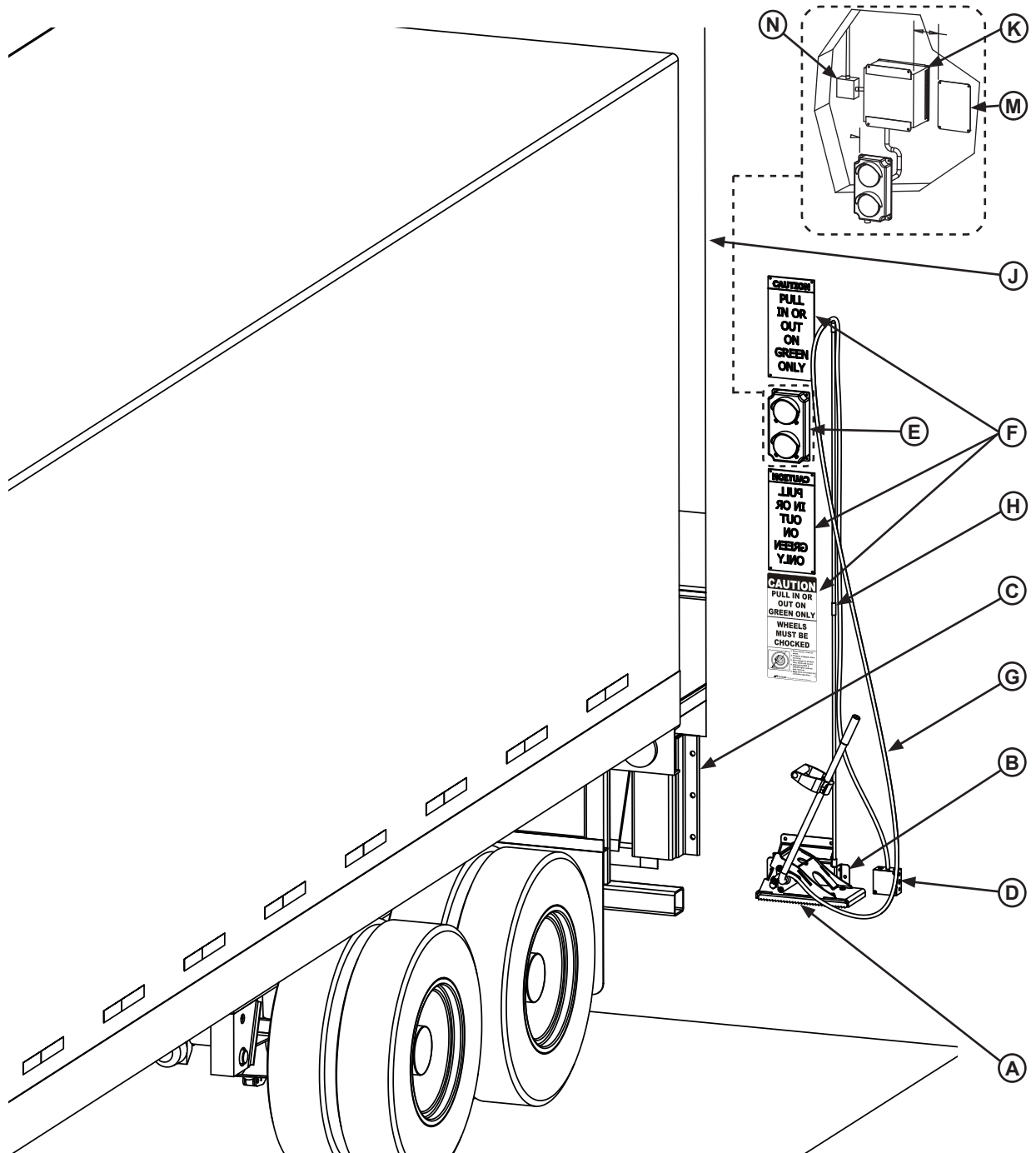
9974-0005 — Standoff Mounting Bracket

Figure 6

# INSTALLATION

## Installation Overview

**Note:** This is a generic overview of a typical UniChock installation. See full installation instructions on pages 12-16 for different installation types and all steps.



**Figure 7**

- |                              |                              |                  |
|------------------------------|------------------------------|------------------|
| A — UniChock                 | E — Outside Light Assembly   | J — Door Opening |
| B — Storage Bracket Assembly | F — Outside Signs            | K — Control Box  |
| C — Bumper                   | G — Cable, 10M, M12 Conn.    | M — Inside Sign  |
| D — Junction Box             | H — Fiberglass Pole Assembly | N — Disconnect   |

# INSTALLATION

## Installation Instructions

### Exterior Component Layout and Planning

1. Determine location for outside light assembly and signs.
    - a. Consider the location of the control box on the inside and the best way to route wiring.
  2. Determine location for the UniChock storage bracket. Need to consider the following:
    - a. Recommend 12"-18" from the drive to the bottom of the bracket. See Figure 8.
    - b. An additional bracket to rotate storage bracket 90 degrees is required when distance between the door centerlines is less than 144". See Figure 11 and Figure 13.
- c. A standoff bracket is required for the following conditions.
- Loading docks with dock shelters that protrude out at least 24". See Figure 9.
  - Obstructions on or near the building wall that prevent standard bracket mounting. See Figure 10.
  - Fiberglass rod position with respect to door seals and shelters, outside light assembly, and signs.

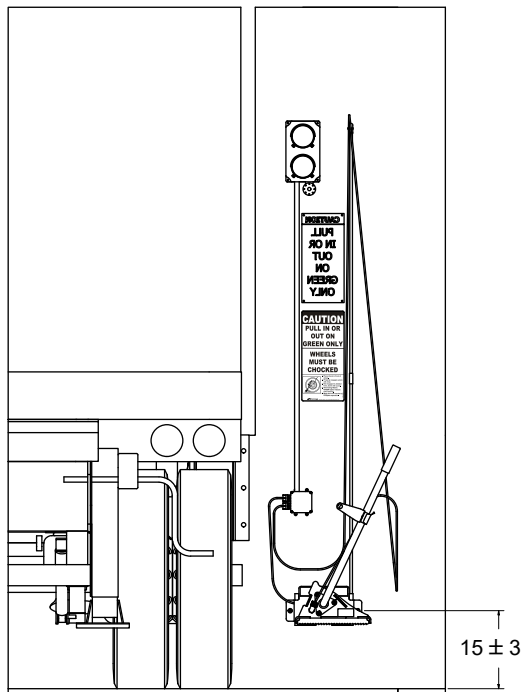


Figure 8

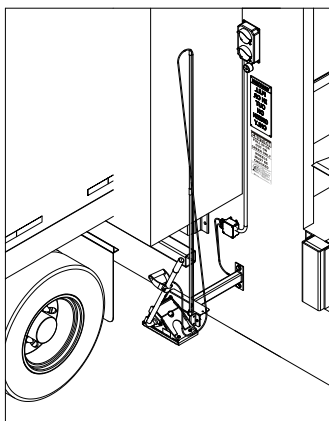
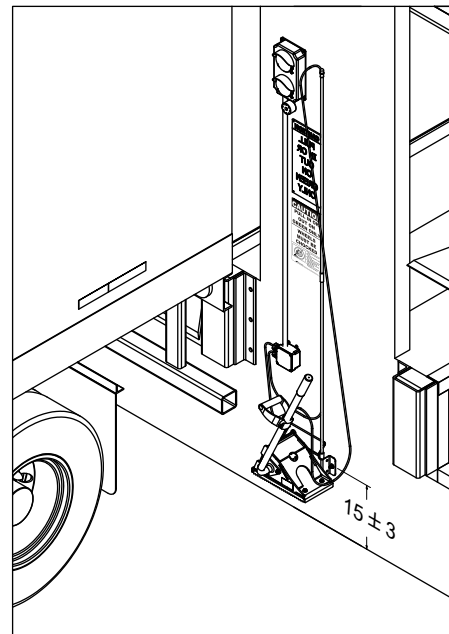


Figure 9

3. Determine location for J-box on the building wall.
  - a. Recommend mounting above the storage bracket and clear from the area the fiberglass rod will be.
  - b. Recommend considering the outside light assembly location to be able to easily route conduit from the J-box to the outside light assembly to route wiring from the chock sensors into the control box.

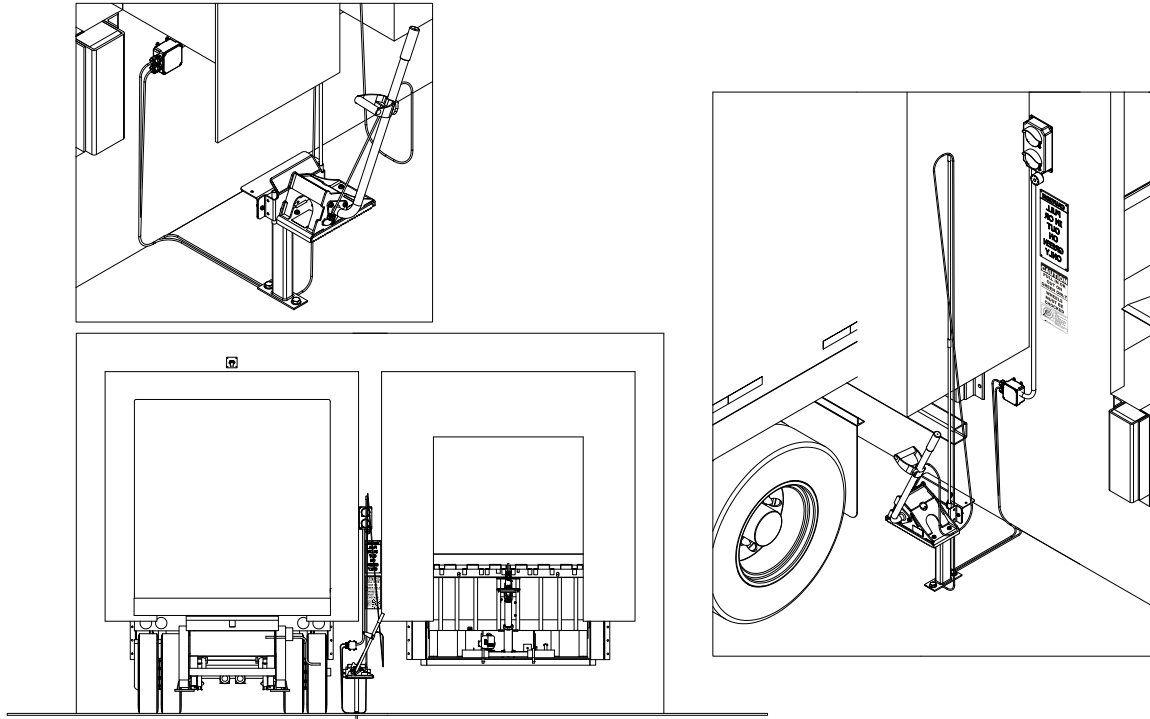


Figure 10

## **Component Installation**

1. Outside Light Assembly. Mount light assembly to the building wall.
2. UniChock Storage Bracket
  - a. If mounting directly to the building wall:
    - Locate 12" to 18" off the drive to the bottom of the bracket. See Figure 8.
    - Make sure chock handle will not interfere with operation of neighboring loading dock.
    - Make sure fiberglass rod does not interfere with any obstructions on the building wall.
    - Two concrete anchors are supplied with the UniChock kit. If bracket is being secured to a different building material, installer will need to supply mounting hardware.
  - b. If mounting to additional bracket to rotate chock 90 degrees (optional). See Figure 11 and Figure 13.

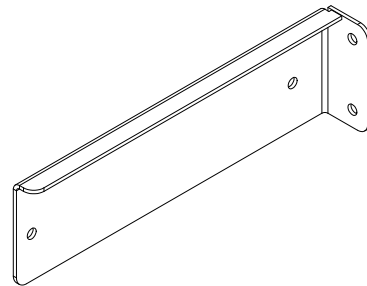


Figure 11

- Locate 12" to 18" off the drive to the bottom of the bracket.
- Make sure fiberglass rod does not interfere with any obstructions on the building wall.
- Two concrete anchors are supplied with the UniChock kit. If bracket is being secured to a different building material, installer will need to supply mounting hardware.

# INSTALLATION

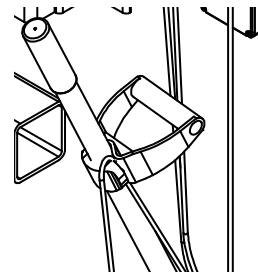
---

3. If mounting to standoff bracket (optional). Standoff bracket can be mounted in two orientations:
  - a. If mounting directly to the building wall. See Figure 9.
    - Locate 12" to 18" off the drive to the bottom of the bracket.
    - Make sure chock handle will not interfere with the operation of the dock next to the one this UniChock is being installed at.
    - Two concrete anchors are supplied with the standoff bracket. If bracket is being secured to a different building material, installer will need to supply mounting hardware.
  - b. If mounting directly to the concrete drive. See Figure 10.
    - Locate bracket on the drive and ensure chock handle clears the dock shelter and does not interfere with the operation of the dock next to the one this UniChock is being installed at.
    - Rotate mounting bracket 90 deg clockwise when distance between door center lines is less than 144".

## 4. Chock Handle

- a. Assemble the chock handle to the chock base using hardware supplied in the UniChock kit. See Figure 15.
- b. May need to reposition the middle handle grip to your desired position. Use allen wrench located on the handle.

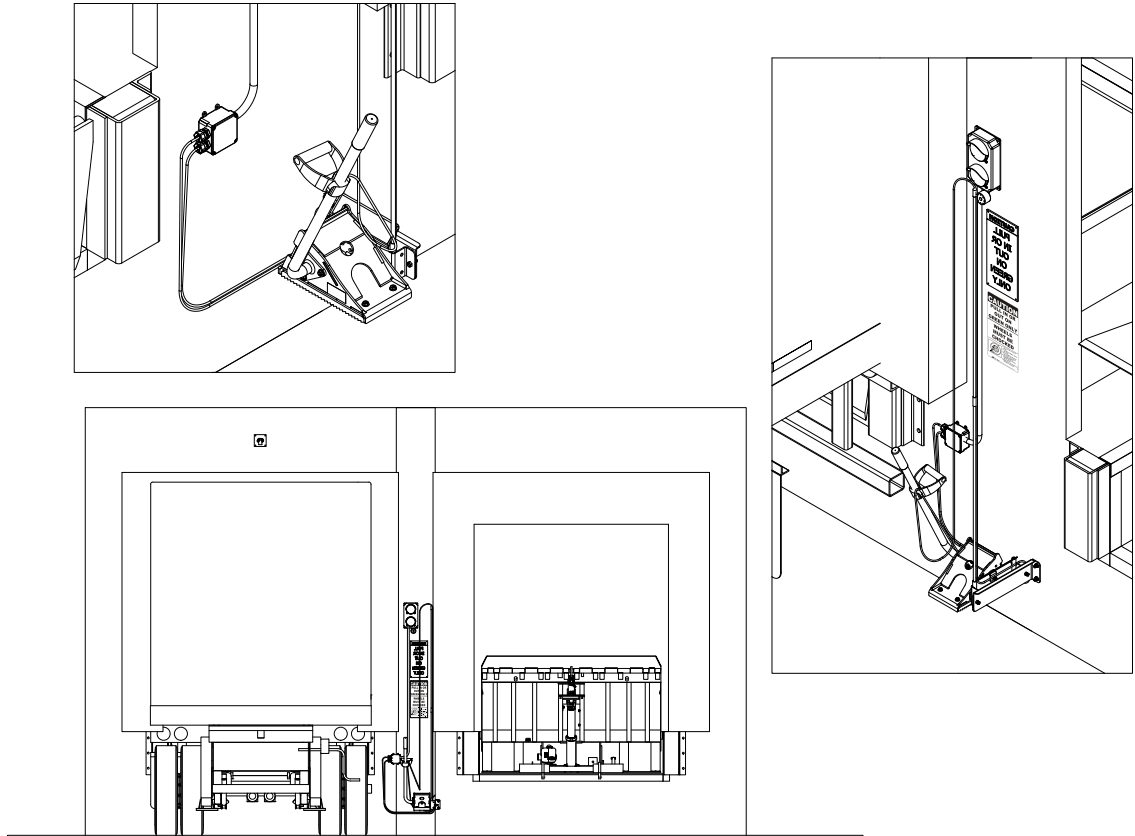
5. Fiberglass Rod and Chock Sensor Cable. See Figure 8.
  - a. Insert the first fiberglass rod into one of the two locations available on the storage bracket. Make sure it will clear any obstructions during use and operation of the chock.
  - b. Insert the second fiberglass rod with the connector piece and rubber tip onto the first rod.
  - c. Place the chock onto the storage bracket.
  - d. Take the sensor cable that is pre-assembled to the chock and uncoil it.
  - e. Route the cable through the middle handle grip to help ensure the cable stays out of the way of the chock and the wheel during operation. See Figure 12.



**Figure 12**

- f. Secure the cable to the rubber tip on the end of the fiberglass rod using the supplied zip ties. Securing this zip tie over the rubber tip will prevent the possibility of the zip tie sliding down the fiberglass rod during use of the UniChock. To determine the amount of slack in the cable between the fiberglass rod and the chock, let the cable loop down towards the chock base but do not allow the cable to loop below the chock base. This will help keep the cable from interfering with the chock during operation and getting caught between the chock base and the storage bracket. Once this slack is set, tightly secure the zip tie around the rubber tip and the cable.
- g. Continue securing the cable along the fiberglass rod assembly using the supplied zip ties.

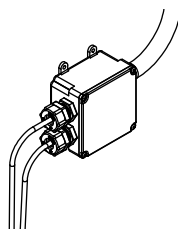




**Figure 13**

**6. J-box for Sensor Cables**

- a. Place the J-box, supplied in the UniChock kit, onto the building wall. See Figure 8.
- b. Drill holes and assemble both cord grips for sensor cables. See Figure 14.



**Figure 14**

- c. Determine wire/conduit routing between the J-box and control box on the inside of the building wall. Recommend using the same wall penetration used to route the wiring for the outside light assembly.

**7. Stored Sensor & Chock Sensor Cables**

- a. Route cables into J-box and if long enough route directly to the control box. If not long enough, installer will need to supply additional cable and make the appropriate spliced connections.
- b. For the chock sensor cable, allow for extra cable inside the J-box. Cut the cable and strip back the wires on both sides. Use the lever nut supplied in the UniChock kit to splice the cable back together. Purpose of this spliced connection is to make it easier for the customer to replace the chock sensor cable if it becomes damaged during use and operation of the chock.

**8. Door Open Sensor Kit (optional)**

- a. Refer to separate install instructions provided with kit.

**9. Leveler Stored Retrofit Sensor Kit (optional)**

- a. Refer to separate install instructions provided with kit.

# INSTALLATION

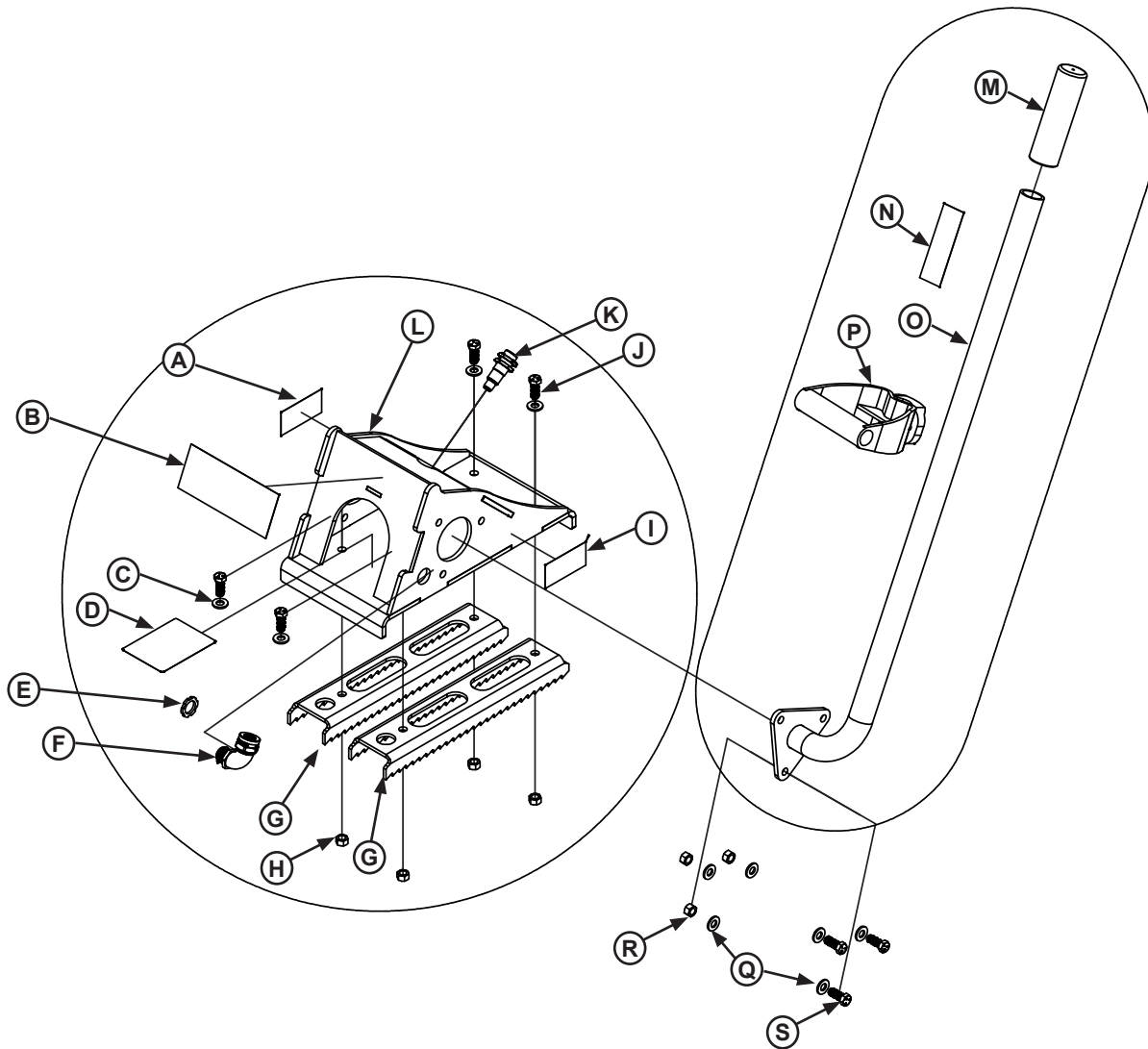


Figure 15

- |                                 |                                     |                                    |                                     |
|---------------------------------|-------------------------------------|------------------------------------|-------------------------------------|
| A — Decal, Caution, Sharp Edges | F — Cord, Grip Mtl, .90             | J — Screw, HHCS, E/8-16 UNC x 1.00 | O — Weldment, Handle                |
| B — Decal, UniChoke Base        | G — Plate, Traction Teeth, Formed   | K — Ultrasonic Sensor, Metal, 1SIG | P — Handle, Plastic Clamp           |
| C — Washer, Flat, Zinc Plated   | H — Hex Nut - Zinc Plated - Grade 5 | L — Weldment, Chock Base           | Q — Lever Nut, 3 Pole               |
| D — Decal, Serial Number        | I — Decal, Caution, Sharp Edges     | M — Handle, Rubber Grip            | R — Washer - Flat - Zinc Plated     |
| E — Lock Nut Cord Grip          |                                     | N — Decal, UniChock Handle         | S — Hex Nut - Zinc Plated - Grade 5 |

## Install Control Panel and Wiring

### **! DANGER**

Make sure that the power source has been locked out and tagged according to OSHA regulations and approved local electrical codes.

### **! WARNING**

A hard hat or other applicable head protection should always be worn when working under or around a dock leveler.

Always stand clear of platform lip when working in front of the dock leveler.

### **! CAUTION**

All electrical work — including the installation of the disconnect panel, control panel, and final connections to the pit junction box — must be performed by a certified electrician and conform to all local and applicable national codes.

## **NOTICE**

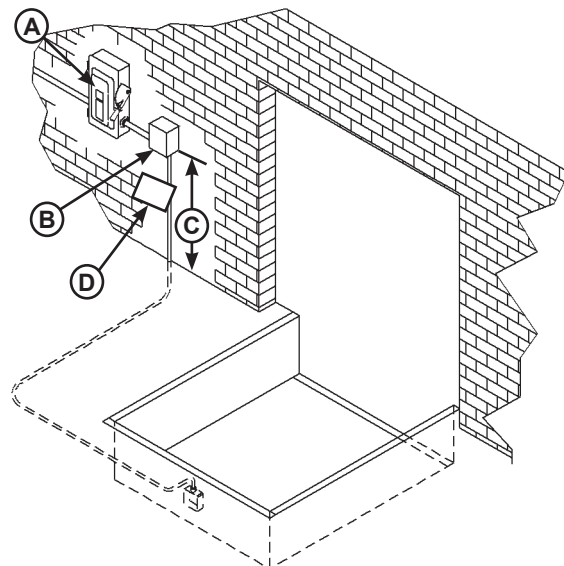
DO NOT connect any dock equipment electrical wiring or ground connections until all welding has been completed.

DO NOT ground welding equipment to any electrical components of the dock equipment. Always ground welding equipment to the dock leveler frame, NEVER to the platform.

Failure to follow these instructions may damage the motor, wiring, and/or control panel.

## **NOTICE**

Where indicated, all components must be connected to a SAFETY EARTH GROUND that conforms to the 1999 National Electrical Code Section 250-50 section (a) or section (c) for a grounding electrode system.



**Figure 16**

**A — Disconnect Panel (provided by others)**      **C — Distance, 48 in. (1219 mm)**  
**B — Control Panel**      **D — Placard**

1. Mount the control panel (B) so bottom of control panel-to-dock floor distance is 48 in. (1219 mm, C).
2. Install electrical disconnect panel (A) if not already installed (provided by others). It is recommended to locate disconnect panel adjacent to control panel (B).
3. Install and connect the control wiring as shown in installation drawings.
4. Connect the control wiring to the field wires in the dock equipment junction boxes. Refer to the electrical diagrams supplied with the dock equipment.

**Note:** When installing electrical controls in a temperature-controlled environment, the installer must determine an appropriate means to isolate/prevent thermal and vapor transfer through electrical conduit, where conduit routing crosses temperature zones. Systems, LLC is not responsible for any damage due to moisture collecting inside the control panel caused by improper isolation/prevention of thermal and vapor transfer through the conduit. Refer to Tech Service Bulletin 19-053 for more information.

5. Install placard (D). Make sure placard is in plain view of dock leveler and/or vehicle restraint operations. Suggested placement of placard is near control box attached to electrical conduit by using nylon cable tie. See page 18.

# INSTALLATION

## Placard Installation Instructions

1. Installers and/or owners/users are responsible for the installation and placement of product placards.
2. Placard must be in plain view of dock leveler and/or vehicle restraint operations.
3. Suggested placement of placard is near control box, attached to the wall or electrical conduit using a cable tie. If the equipment does not have a control panel, mount the placard on the wall to the immediate left of leveler at eye level.

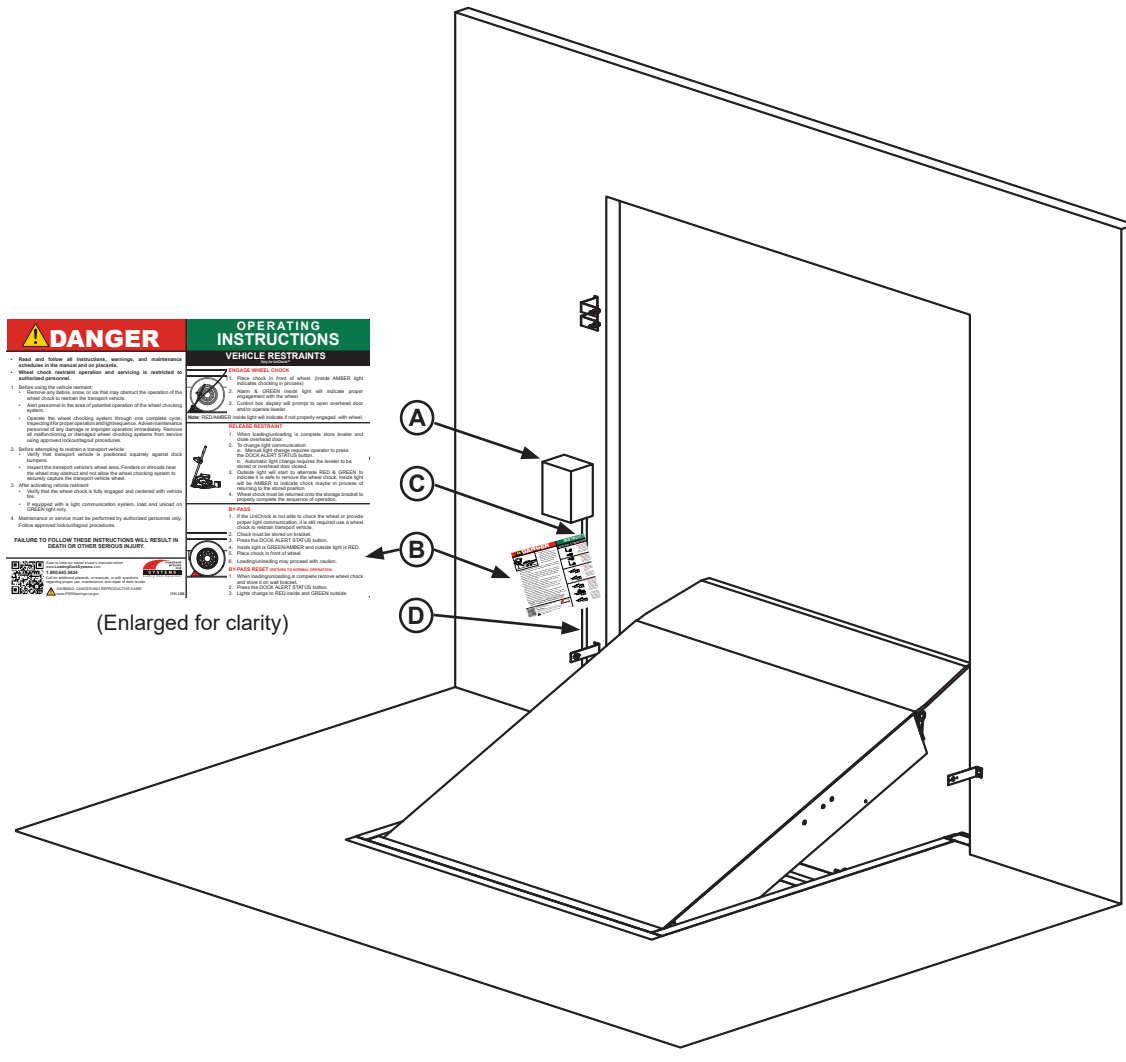


Figure 17

A — Control Box

B — Placard

C — Nylon Cable Tie

D — Conduit

## Operational Precautions

### **DANGER**

Stay clear of dock leveler and vehicle restraint when transport vehicle is entering or leaving dock area.

DO NOT move or use the dock leveler or restraint if anyone is under or in front of leveler.

Keep hands and feet clear of pinch points. Avoid putting any part of your body near moving parts.

### **WARNING**

Only trained personnel should operate the dock leveler and vehicle restraint.

DO NOT use a broken or damaged dock leveler or vehicle restraint. Make sure proper service and maintenance procedures have been performed on the equipment before using.

Transport vehicle wheels must be chocked. Do not remove the restraint until loading/unloading is finished and transport vehicle driver has been given permission to leave.

Make sure platform lip rests on the transport vehicle bed with at least 4 in. (102 mm) of overlap.

Maintain a safe distance from side edges of leveler during the loading/unloading process.

### **WARNING**

Once the vehicle restraint has been positioned, the dock attendant must visually inspect to assure that the restraint has properly engaged the vehicle wheels.

## iDock Controller User Interface:

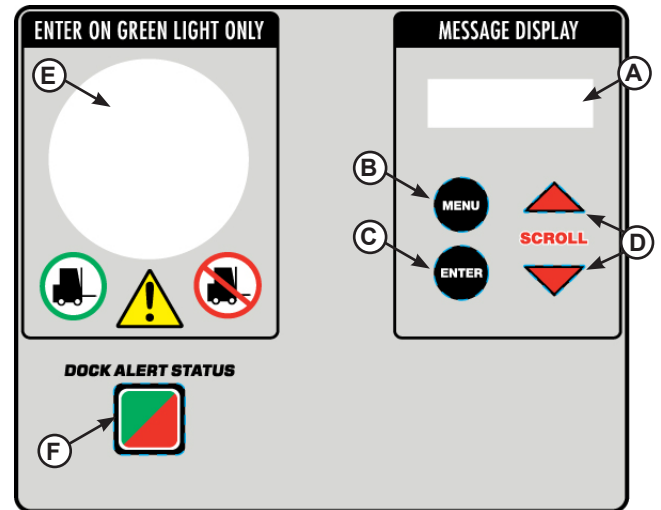


Figure 18

#### System Control Buttons/ Displays

- A — Message Display
- B — MENU button
- C — ENTER button
- D — SCROLL UP/DOWN buttons
- E — Multi-Colored LED Light

#### Equipment Control Buttons

- F — DOCK ALERT STATUS button

# OPERATION

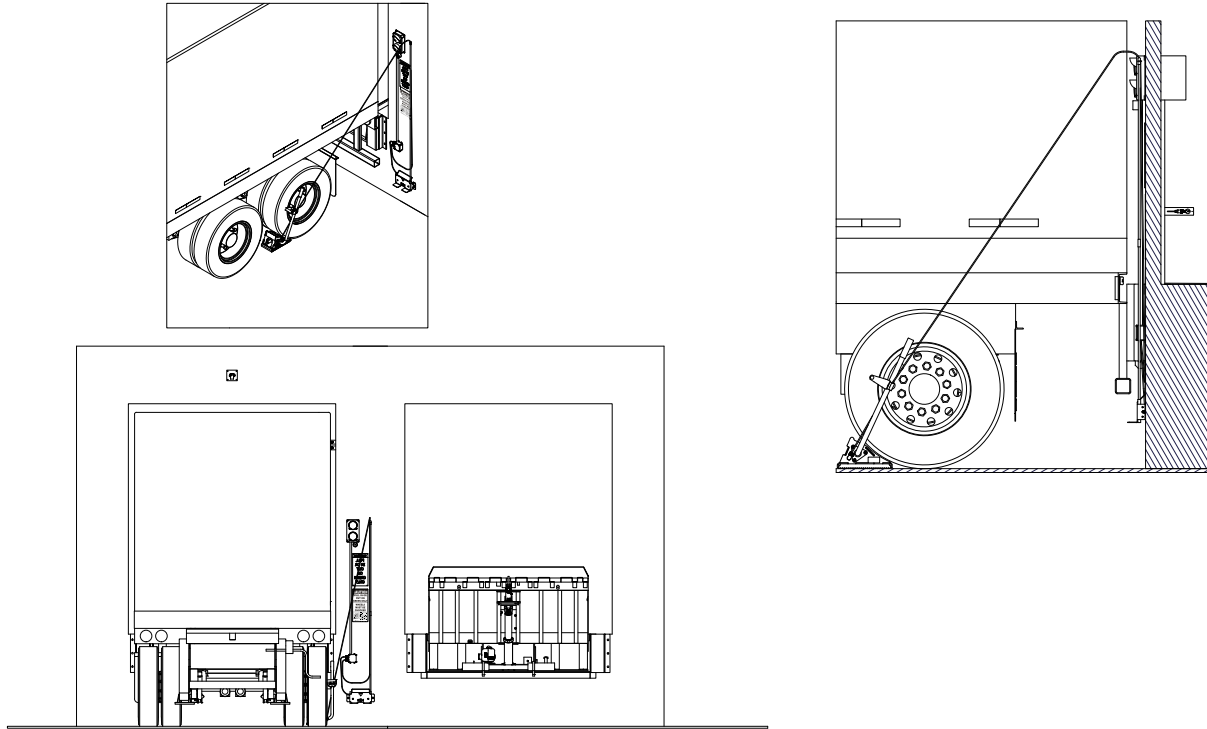


Figure 19

## Operation – Normal – Light Communication: Auto with Door

1. Check that transport vehicle is positioned squarely against both dock bumpers.
2. Remove chock from storage bracket and place in front of the wheel.
  - Outside alarm will indicate when chock is properly engaged.
3. Open dock door.
4. Position leveler in the back of the transport vehicle.
5. Return the leveler to the stored position.
6. Close dock door.
  - At this time the controls will notify on the outside of the building that it is safe to remove the chock and return it to the storage bracket.
7. Return the chock to the storage bracket.
8. Sequence of operation complete.

## Operation – Normal – Light Communication: Auto with Leveler






























1. Check that transport vehicle is positioned squarely against both dock bumpers.
2. Remove chock from storage bracket and place in front of the wheel.
  - Outside alarm will indicate when chock is properly engaged.
3. Open dock door.
4. Position leveler in the back of the transport vehicle.
5. Return the leveler to the stored position.
  - At this time the controls will notify on the outside of the building that it is safe to remove the chock and return it to the storage bracket.
6. Close dock door.
7. Return the chock to the storage bracket.
8. Sequence of operation complete.

## Configuration Notes



### Factory Configuration




















- Door operated lights
- Interlock (RELO) Restraint Engaged before Leveler Operate
- Sequence of Operation Truck → Restraint → Door → Leveler → Door → Restraint → Truck

### System Operating Procedure & Light Sequence

Step	Outside Light Assembly	Outside Alarm	Inside Light Red/Green	Inside Light Amber	Inside Alarm	Description
1						<ul style="list-style-type: none"> <li>• Vehicle Not Present</li> <li>• Restraint Stored (Chock in storage bracket)</li> <li>• Door Closed</li> <li>• Leveler Stored</li> </ul>
2						<ul style="list-style-type: none"> <li>• <b>Vehicle Present</b></li> <li>• Restraint Stored (Chock in storage bracket)</li> <li>• Door Closed</li> <li>• Leveler Stored</li> </ul>
3						<ul style="list-style-type: none"> <li>• <b>Restraint Removed from Stored Position</b></li> <li>• Door Closed</li> <li>• Leveler Stored</li> </ul>
4		 Momentary			 Momentary	<ul style="list-style-type: none"> <li>• <b>Restraint Engaged (Chock in front of wheel)</b></li> <li>• Door Closed</li> <li>• Leveler Stored</li> </ul>
5						<ul style="list-style-type: none"> <li>• Restraint Engaged</li> <li>• <b>Door Open</b></li> <li>• Leveler Stored</li> </ul>
		 Continuous			 Continuous	<p>If the restraint is pulled from the engaged position, the lights will change, and the outside alarm will sound to get the attention of the operator. Fault #11 will occur after a delay (see Fault #11 details below)</p> <p>Fault condition in the controls will clear once chock is reengaged with the wheel.</p>
6						<ul style="list-style-type: none"> <li>• Restraint Engaged</li> <li>• Door Open</li> <li>• <b>Leveler Deployed</b></li> </ul>
7						<ul style="list-style-type: none"> <li>• Restraint Engaged</li> <li>• Door Open</li> <li>• <b>Leveler Stored</b></li> </ul>
8		 Momentary				<ul style="list-style-type: none"> <li>• <b>Close Door to give permission to Store Restraint</b></li> <li>• Leveler Stored</li> </ul>
9						<ul style="list-style-type: none"> <li>• <b>Restraint Removed from the Engaged Position</b></li> <li>• Door Closed</li> <li>• Leveler Stored</li> </ul>
10						<ul style="list-style-type: none"> <li>• <b>Restraint Stored</b></li> <li>• Door Closed</li> <li>• Leveler Stored</li> </ul>

# OPERATION

Step	Outside Light Assembly	Outside Alarm	Inside Light Red/Green	Inside Light Amber	Inside Alarm	Description
11						<ul style="list-style-type: none"> <li>• <b>Vehicle Not Present</b></li> <li>• Restraint Stored</li> <li>• Door Closed</li> <li>• Leveler Stored</li> </ul>

FAULT CONDITIONS						
Fault #9						<p><b>Sensor Error</b></p> <ul style="list-style-type: none"> <li>• If the sensors indicate that the chock is stored and engaged at the same time.</li> <li>• Must fix fault condition before it will clear on the control box.</li> <li>• <b>Press ENTER</b> on the control box to clear fault.</li> </ul>
Fault #10		 Momentary				<p><b>Improper Chock Position (Restraint not Engaged)</b></p> <ul style="list-style-type: none"> <li>• Occurs in 2 scenarios               <ul style="list-style-type: none"> <li>• After chock is removed from the stored position and not engaged with the wheel within 30 seconds.</li> <li>• After chock is engaged, but before door is open and chock/wheel has moved where the chock is not detecting the wheel.</li> </ul> </li> <li>• Either return chock to the stored position or engage with wheel to clear fault condition.</li> </ul>
Fault #11		 Continuous				<p><b>Improper Chock Position (Reengage Failure)</b></p> <ul style="list-style-type: none"> <li>• Occurs after chock is engaged with the wheel and the door has been opened, and chock no longer senses the wheel.</li> <li>• Must return chock to the engage position with wheel to clear fault condition.</li> </ul>
Fault #13		 Momentary				<p><b>Improper Chock Position (Not Returned to Stored Position)</b></p> <ul style="list-style-type: none"> <li>• Occurs after chock is removed from the wheel and is not returned to the stored position with 6 seconds after permission is given.</li> <li>• Must return chock to the stored position to clear fault condition.</li> </ul>



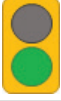


























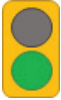

## Factory Configuration

- Leveler operated lights
- Interlock (RELO) Restraint Engaged before Leveler Operate
- Sequence of Operation Truck → Restraint → Door → Leveler → Door → Restraint → Truck

## System Operating Procedure & Light Sequence

Step	Systems UniChock					Description
	Outside Light Assembly	Outside Alarm	Inside Light Red/Green	Inside Light Amber	Inside Alarm	
1 Vehicle Not Present						<ul style="list-style-type: none"> <li>• Vehicle Not Present</li> <li>• Restraint Stored (Chock in storage bracket)</li> <li>• Door Closed</li> <li>• Leveler Stored</li> </ul>
2 Vehicle Present						<ul style="list-style-type: none"> <li>• <b>Vehicle Present</b></li> <li>• Restraint Stored (Chock in storage bracket)</li> <li>• Door Closed</li> <li>• Leveler Stored</li> </ul>
3 Chock Removed from Stored Position						<ul style="list-style-type: none"> <li>• <b>Restraint Removed from Stored Position</b></li> <li>• Door Closed</li> <li>• Leveler Stored</li> </ul>
4 Chock Engaged with Wheel		 Momentary			 Momentary	<ul style="list-style-type: none"> <li>• <b>Restraint Engaged (Chock in front of wheel)</b></li> <li>• Door Closed</li> <li>• Leveler Stored</li> </ul>
5 Open Door						<ul style="list-style-type: none"> <li>• Restraint Engaged</li> <li>• <b>Door Open</b></li> <li>• Leveler Stored</li> </ul>
						If the restraint is pulled from the engaged position, the lights will change, and the outside alarm will sound to get the attention of the operator.
6 Leveler Deployed						<ul style="list-style-type: none"> <li>• Restraint Engaged</li> <li>• Door Open</li> <li>• <b>Leveler Deployed</b></li> </ul>
7 Leveler Stored		 Momentary				<ul style="list-style-type: none"> <li>• Restraint Engaged</li> <li>• Door Open</li> <li>• <b>Leveler Stored</b></li> </ul>
8 Close Door						<ul style="list-style-type: none"> <li>• <b>Close Door</b></li> <li>• Leveler Stored</li> </ul>
9 Chock Removed from the Wheel						<ul style="list-style-type: none"> <li>• <b>Restraint Removed from the Engaged Position</b></li> <li>• Door Closed</li> <li>• Leveler Stored</li> </ul>
10 Chock Stored						<ul style="list-style-type: none"> <li>• <b>Restraint Stored</b></li> <li>• Door Closed</li> <li>• Leveler Stored</li> </ul>

# OPERATION

Step	Systems UniChock					Description
	Outside Light Assembly	Outside Alarm	Inside Light Red/Green	Inside Light Amber	Inside Alarm	
11 Vehicle Not Present						<ul style="list-style-type: none"> <li>• <b>Vehicle Not Present</b></li> <li>• Restraint Stored</li> <li>• Door Closed</li> <li>• Leveler Stored</li> </ul>
Fault #9						<p><b>Sensor Error</b></p> <ul style="list-style-type: none"> <li>• If the sensors indicate that the chock is stored and engaged at the same time.</li> <li>• Must fix fault condition before it will clear on the control box.</li> <li>• Press ENTER on the control box to clear fault.</li> </ul>
Fault #10		 Momentary				<p><b>Improper Chock Position (Restraint not Engaged)</b></p> <ul style="list-style-type: none"> <li>• Occurs in 2 scenarios</li> <li>• After chock is removed from the stored position and not engaged with the wheel within 30 seconds.</li> <li>• After chock is engaged, but before door is open and chock/wheel has moved where the chock is not detecting the wheel.</li> <li>• Either return chock to the stored position or engage with wheel to clear fault condition.</li> </ul>
Fault #11		 Continuous				<p><b>Improper Chock Position (Reengage Failure)</b></p> <ul style="list-style-type: none"> <li>• Occurs after chock is engaged with the wheel and the door has been opened, and chock no longer senses the wheel.</li> <li>• Must return chock to the engage position with wheel to clear fault condition.</li> <li>• Comments with Rite Hite system</li> <li>• Fault will not occur until after the "LOCK" button is pressed.</li> </ul>
Fault #13		 Momentary				<p><b>Improper Chock Position (Not Returned to Stored Position)</b></p> <ul style="list-style-type: none"> <li>• Occurs after chock is removed from the wheel and is not returned to the stored position with 6 seconds after permission is given.</li> <li>• Must return chock to the stored position to clear fault condition.</li> </ul>
1 - Bypass						<ul style="list-style-type: none"> <li>• <b>Chock in Stored Position</b></li> </ul>
2 – Bypass To start bypass						<ul style="list-style-type: none"> <li>• Chock must be in stored position for bypass to work.</li> <li>• Press "DOCK STATUS" button</li> </ul>
2 – Bypass To return to normal						<ul style="list-style-type: none"> <li>• Press "DOCK STATUS" button</li> </ul>

## Periodic Maintenance

### Daily Maintenance

- Verify that all inside and outside signal lights and alarms are working correctly.

### Weekly Maintenance

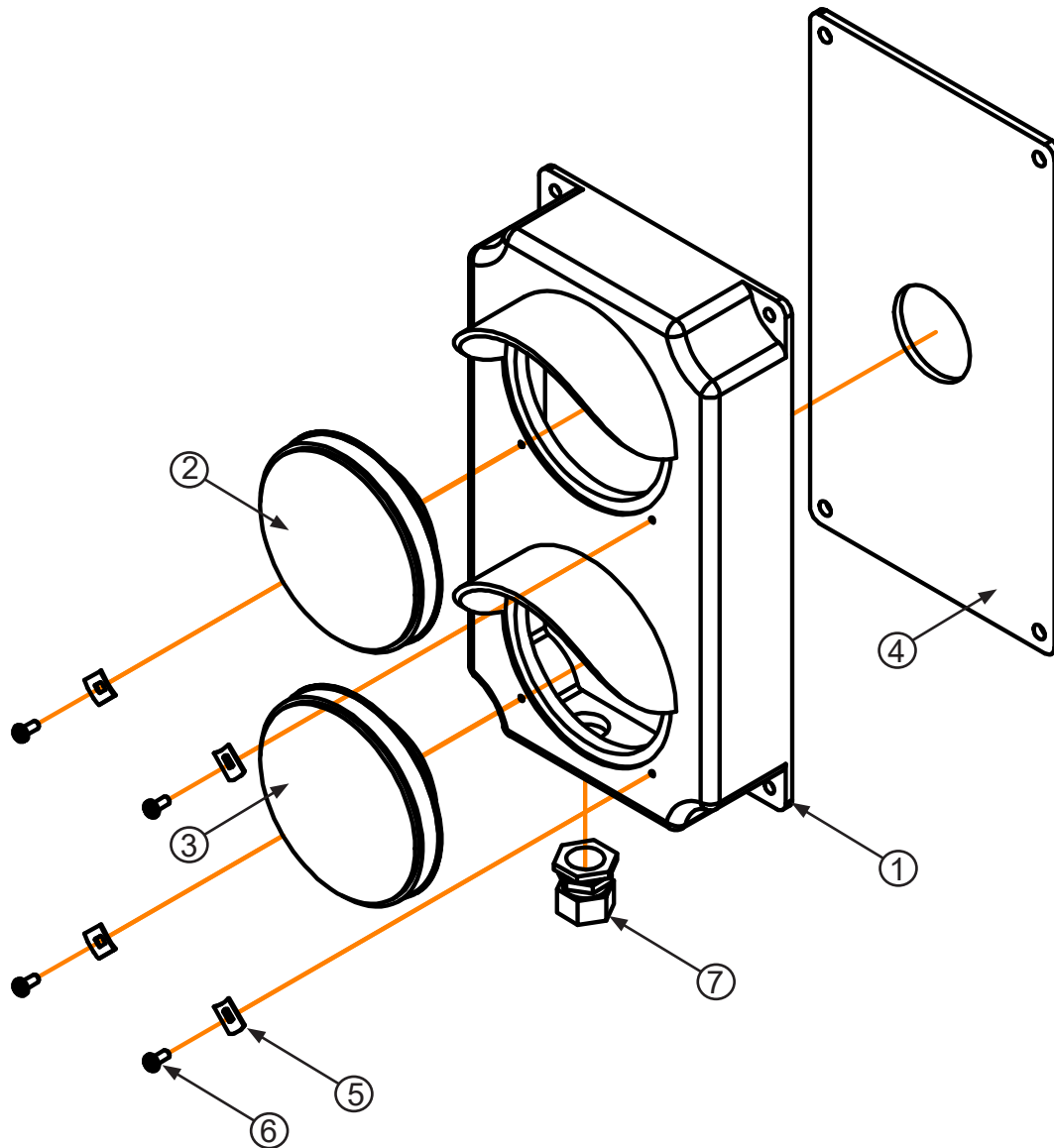
- Inspect the sensor cable that extends from the storage bracket to the chock to make sure there are no cuts or damage. Make sure the cable is still properly secured to the fiberglass rod.
- Inspect the chock handle for any damage that may cause it difficult to operate.
- Remove debris around the area the chock will be used to ensure proper chocking support.
- Inspect warning decals and placards. Replace if damaged or missing.

### Quarterly Maintenance

- Inspect the following for damage/abnormal wear:
  - Traction teeth on the bottom of the chock.
  - Chock base for bent material or cracked welds.
  - Chock handle for bent material or cracked welds.
  - Fiberglass rod for deterioration or cracking.

# PARTS

## OSLA (Outside Light Assembly)



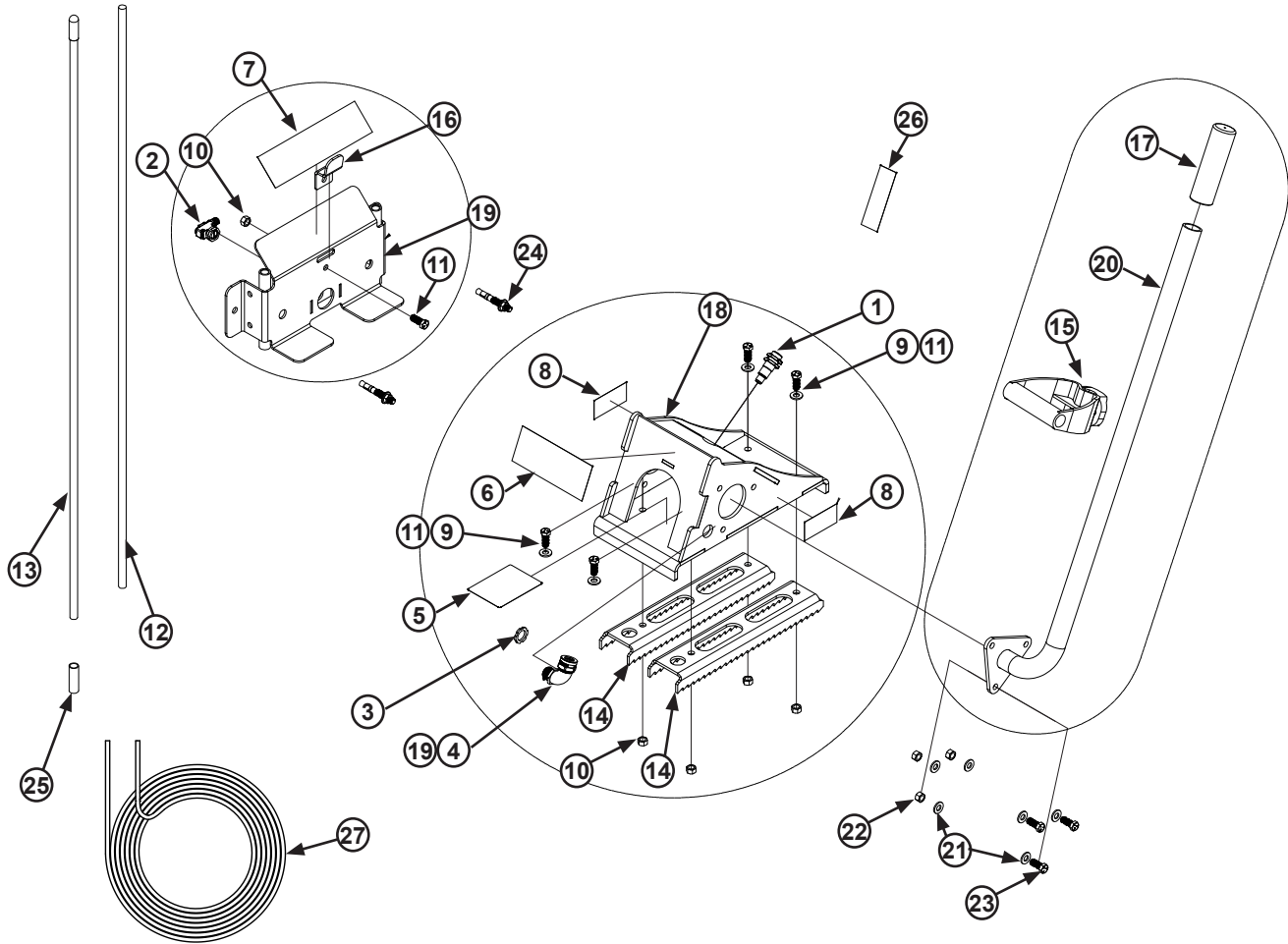
Item	Quantity	Part Number	Description
1-7	1	3055-0011	Complete Light Housing, Yellow Plastic, With LED Lights
1	1	3051-0063	Housing, Main, Yellow
2	1	3051-0147	Red LED Lens/Housing/Circuit Assembly, 12v
3	1	3051-0149	Green LED Lens/Housing/Circuit Assembly, 12v
4	1	3051-0068	Mounting Gasket
5	4	3051-0105	Clip, Lens Holding
6	4	3051-0104	Screw, Lens Holding
7	1	*	Conduit Fastener, 3/4" x 3/8"

Signs



Item	Part Number	Description
A	1751-1391	Outside Sign, Pull In/Out, UniChock
B	1751-0033	Outside Sign, Pull In/Out
C	1751-0034	Outside Sign, Pull In/Out (Mirror)
D	1751-0036	Inside Sign, Enter on Green Only

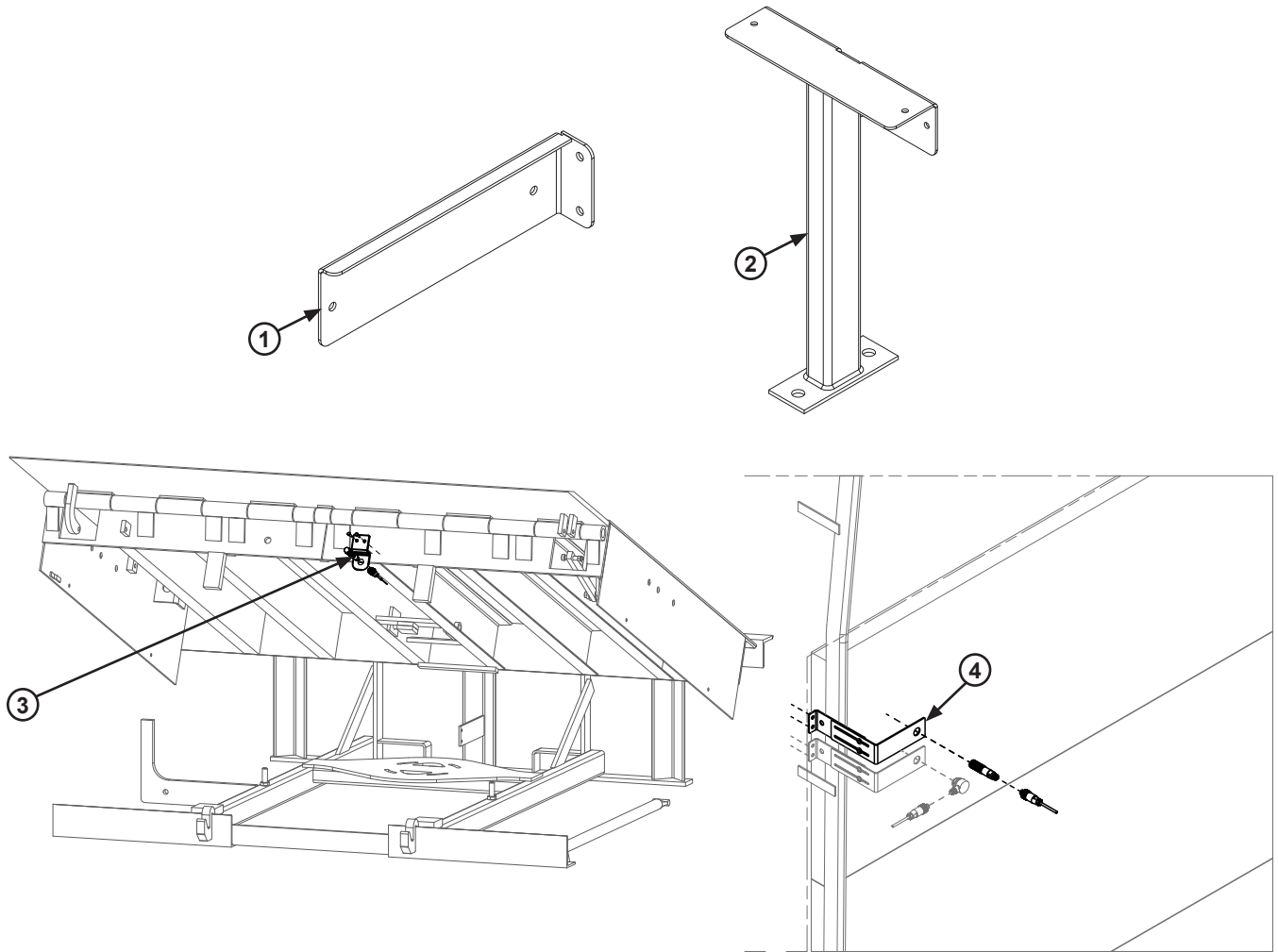
# PARTS



Item	Part Number	Description
1	0961-0691	Ultrasonic Sensor, Metal, 1SIG
2	0961-0690	Sensor, Photo, Fixed Field
3	1431-0124	Lock Nut Cord Grip
4	1431-0367	Cord Grip, Metal, 90
5	1751-1290	Decal, Serial Number
6	1751-1371	Decal, UniChock Base
7	1751-1372	Decal, UniChock, Storage Bracket
8	1751-1378	Decal, Caution, Sharp Edges, English
	1751-1394	Decal, Caution, Sharp Edges, Spanish
	1751-1395	Decal, Caution, Sharp Edges, French
9	2101-0060	Washer, Flat, Zinc Plated
10	2101-0207	Hex Nut - Zinc Plated - Grade 5
11	2101-0273	Screw, HHCS, 3/8-16 UNC X 1.00
12	3051-0410	Fiberglass Rod, Solid
13	3051-0412	Vinyl End Cap, .500"
14	9971-0022	Plate, Traction Teeth, Formed

Item	Part Number	Description
15	9971-0028	Handle, Plastic Clamp
16	9971-0029	Bracket, Hook, Formed
17	9971-0040	Handle, Rubber Grip
18	9974-0001	Weldment, Chock Base
19	9974-0003	Weldment, Storage Base
20	9974-0004	Weldment, Handle
21	1431-0291	Lever Nut, 3 Pole
22	2101-0060	Washer - Flat - Zinc Plated
23	2101-0207	Hex Nut - Zinc Plated - Grade 5
24	2101-0403	Anchor, Concrete Stud
25	3051-0411	Ferrule, Aluminum
26	1751-1402	Decal, UniChock Handle
27	0961-0648	Cable, Storage Bracket, 5M, M12 Plug, Flying Leads
	4301-0035	Cable, Chock, 8M, M12, 5-pin

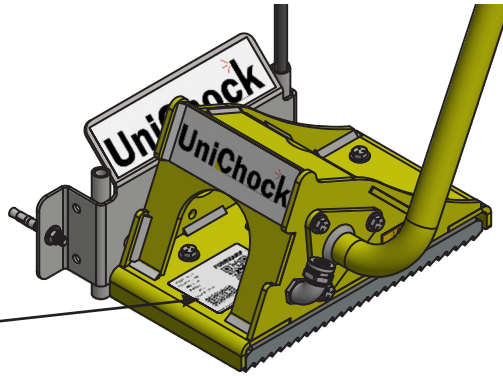
## Optional Parts



Item	Part Number	Description
1	9971-0034	90 deg Bracket, Mounting, Formed
2	9974-0005	Weldment, Storage Standoff Base
3	7155-0009	Kit, LS Retrofit, 120 VAC, with Bracket and Cable
4	7155-0010	Kit, Door Open Sensor, 10-30 VDC, Bracket, Cable

# MISCELLANEOUS

## Customer Information



When you receive your new equipment, write down the model and serial number in the form provided. This will help ensure safe keeping of the numbers in the event the model/serial number decal becomes lost or damaged.

Also, write down Systems, LLC's order number, the company that installed the equipment, and the original owner's name. This will all help to identify the specific equipment if more information is required.

When ordering, use part numbers and description to help identify the item ordered. Do not use "item" numbers. These are only for locating the position of the parts. Always give MODEL NUMBER and/or SERIAL NUMBER.

For service, call or contact:

Systems, LLC  
P.O. Box 309  
Germantown, WI 53022

Phone: (800) 643-5424  
Fax: (262) 255-5917

[www.loadingdocksystems.com](http://www.loadingdocksystems.com)

### Vehicle Restraint Information

Model \_\_\_\_\_

Serial No. \_\_\_\_\_

Systems, LLC Order No. \_\_\_\_\_

### Original Owner Information

Name \_\_\_\_\_

Address \_\_\_\_\_

\_\_\_\_\_

### Installer Information

Name \_\_\_\_\_

Address \_\_\_\_\_

\_\_\_\_\_

Date of Installation \_\_\_\_\_





# NOTES

---

This page intentionally left blank.

## **STANDARD PRODUCT WARRANTY**

SYSTEMS, LLC warrants that its products will be free from defects in design, materials and workmanship for a period of one (1) year from the date of shipment. All claims for breach of this warranty must be made within 30 days after the defect is or can with reasonable care, be detected. In no event shall any claim be made more than 30 days after this warranty has expired. In order to be entitled to the benefits of this warranty, the product must have been properly installed, maintained and operated in accordance with all manufacturer's recommendations and/or specified design parameters and not otherwise have been subject to abuse, misuse, misapplication, acts of nature, overloading, unauthorized repair or modification, application in a corrosive environment or lack of maintenance. Periodic lubrication, adjustment and inspection in accordance with all manufacturers' recommendations are the sole responsibility of the Owner/User.

In the event of a defect, as determined by SYSTEMS LLC, covered by this warranty, SYSTEMS LLC shall remedy such defect by repairing or replacing any defective equipment or parts, bearing the cost for the parts, labor and transportation. This shall be exclusive remedy for all claims whether based on contract, negligence or strict liability.

## **WARRANTY LIMITATIONS**

THE ABOVE WARRANTIES ARE IN LIEU OF ANY OTHER WARRANTIES, WHETHER EXPRESSED OR IMPLIED, INCLUDING BUT NOT LIMITED TO ANY IMPLIED WARRANTY OF MERCHANTABILITY OR FITNESS FOR A PARTICULAR PURPOSE. SYSTEMS LLC AND ITS SUBSIDIARIES SHALL NOT IN ANY EVENT BE LIABLE TO ANYONE, INCLUDING THIRD PARTIES, FOR INCIDENTAL, CONSEQUENTIAL OR SPECIAL DAMAGES OF ANY KIND INCLUDING BUT NOT LIMITED TO, BREACH OF WARRANTY, LOSS OF USE, LOSS OF PROFIT, INTERRUPTION OF BUSINESS OR LOSS OF GOODWILL.